

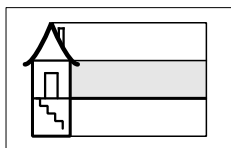









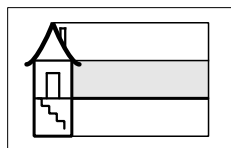

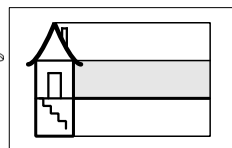

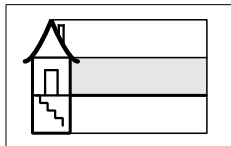
Name: \_\_\_\_\_

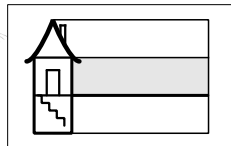
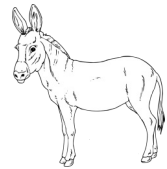
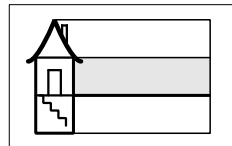
1 Welchen Anlaut hörst du?

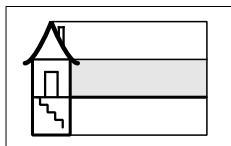

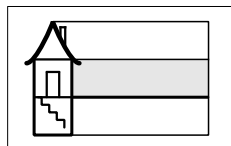
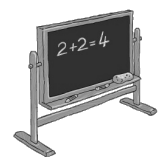
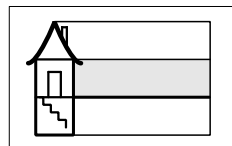

2 Wo hörst du den Laut? Anfang - Mitte - Schluss

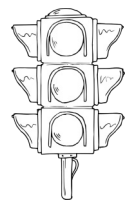

A, a

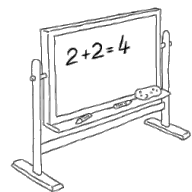
		
<input type="text"/>	<input type="text"/>	<input type="text"/>

E, e

		
<input type="text"/>	<input type="text"/>	<input type="text"/>

O, o

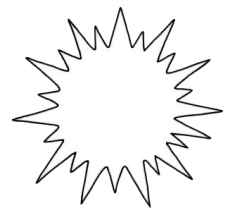
		
<input type="text"/>	<input type="text"/>	<input type="text"/>